

DESCRIPTION

The MESO 50W LED drivers are designed to generate one constant current output from an AC input, and work with most industry standard lighting controls in dimming applications. Optional Remote Gear and Ballast Mounting Kits are available to meet a wide range of mounting applications from a single model.



KEY FEATURES

- 120-277 V_{AC} Input
- DC Input Rated models available – DC input status is automatically detected by the unit
- Easily programmed output features via RFID wireless, wired tools or via simple resistor
- Standby power consumption <0.5W
- Dimming Options (3% minimum):
 - Analog Dimming Models
 - 1-10V / 0-10V Dim (dims to OFF)
 - Push/Step Dim
 - DALI Dimming Models
 - 1-10V / 0-10V Dim (dims to OFF)
 - DALI/PWM
 - Push/Step Dim
- Temperature sensor input (NTC) to protect the LED
- UL Approved, ENEC Approved, CE Mark
- Class 2 Output ⁴, Class II isolation
- Long Life – 50k hours @80°C case (T_c)
- RoHS Compliant



MODEL CODING AND OUTPUT RATINGS

Model Number		Rating				
Base Model Number	Option Letter ¹	Pout Max (W)	Vout Min (VDC)	Vout Max ² (VDC)	Iout ² Set (mA)	Iout Max ³ (mA)
RM50LD-1400A-		50	20	40	700	1400
RM50LD-1050A-		50	28	56	500	1050
RM50LD-700A ⁴ -		50	50	100	350	700

Note 1: Two characters are required to define the options. See the Option Table for details.

Note 2: The factory set point for all models is the Iout Set.

Note 3: Each model is power limited to 50W. Refer to output rating graphs on page 2.

Note 4: Model RM50LD-700A-XX is not a Class 2 output

Option Table	
Option Letter	Description
AA	AC Input and Analog – 0-10V Dimming
AD	AC Input and Digital – DALI Dimming
DA	AC & DC Input and Analog – 0-10V Dimming
DD	AC & DC Input and Digital – DALI Dimming

INPUT SPECIFICATIONS

Specification	Test Conditions / Notes	Min.	Nominal	Max.	Units
AC Input Voltage	Device starts and operates at 90V _{AC} at all load conditions 120-250V _{AC} for Europe; 120-277V _{AC} for USA and Canada	90	120-277	305	V _{AC}
DC Input Voltage¹	120-250V _{DC} for Europe; 150-400V _{DC} for USA and Canada	120	-	400	V _{DC}
Input Frequency		47	50/60	63	Hz
Input Current	120V _{AC} Rated Load	-	-	0.50	A
	230V _{AC} Rated Load	-	-	0.26	
	277V _{AC} Rated Load	-	-	0.22	
Inrush Current	120V _{AC}	-	-	2.5	A _{pk}
	230V _{AC}	-	-	4.0	
	277V _{AC}	-	-	5.3	
THD	120V _{AC} Rated Load	-	-	10	%
	230V _{AC} Rated Load	-	-	15	
	277V _{AC} Rated Load	-	-	20	
Efficiency	120V _{AC} Rated Load	86	-	89	%
	230V _{AC} Rated Load	87	-	89	
	277V _{AC} Rated Load	86	-	88	
Stand by Power Consumption	120V _{AC}	-	-	0.30	W
	230V _{AC}	-	-	0.42	
	277V _{AC}	-	-	0.49	
Power Factor	120V _{AC} Rated Load	0.97	-	0.99	
	230V _{AC} Rated Load	0.95	-	0.97	
	277V _{AC} Rated Load	0.94	-	0.95	
Harmonic Current	Complies with EN-61000-3-2, Class C load >25W.				

Note 1: DC Input Rated models only; CB and UL test reports.

OUTPUT SPECIFICATIONS

Specification	Test Conditions / Notes	Min.	Nom.	Max.	Units
Output Power Rating	All models, Power limiting	-	-	50	W
Output Voltage	RM50LD-1400A	20	-	40	V
	RM50LD-1050A	28	-	56	
	RM50LD-700A	50	-	100	
Output Current	RM50LD-1400A	700	-	1400	mA
	RM50LD-1050A	500	-	1050	
	RM50LD-700A	350	-	700	
Ripple Current	All models measured (I _{out_Pk-pk} /RMS)	-	-	40	%
Output Regulation		-	-	±5	%I _{out}
Start-up time²	With no dimmer connected	-	-	500	ms

Note 2: Turn-on time on Analog models is faster than DALI models.

PROTECTION FEATURES

Specification	Test Conditions / Notes	Min.	Nominal	Max.	Units
Output Over Voltage	Unit shuts Down and latches off after 5 attempts	110	-	130	%V _{MAX}
Output Short-Circuit	Unit shuts Down and latches off after 10 attempts	-	-	-	-
Over-Temperature Top Case	Power derating, auto Recovery		90		°C
No Load	Unit shuts Down and latches off after 5 attempts				
Isolation Primary-to-Secondary	Reinforced/double Insulation meets IEC/EN61347-2-13 Class II				

OUTPUT RATING GRAPHS

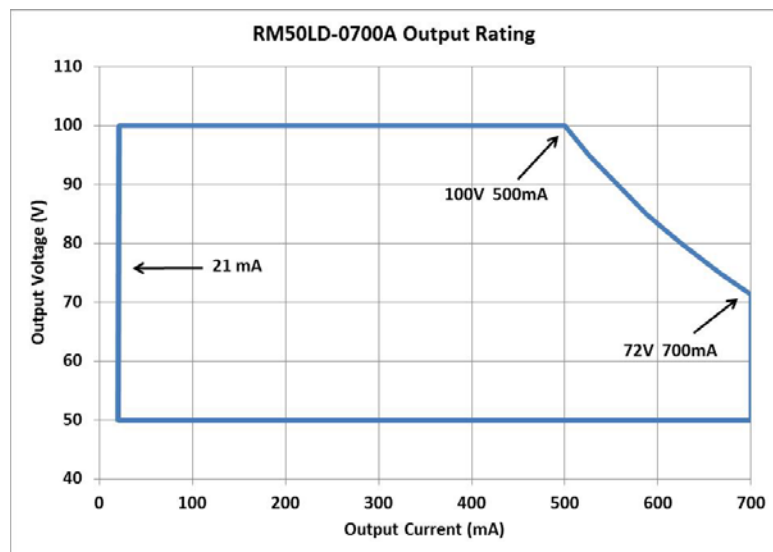
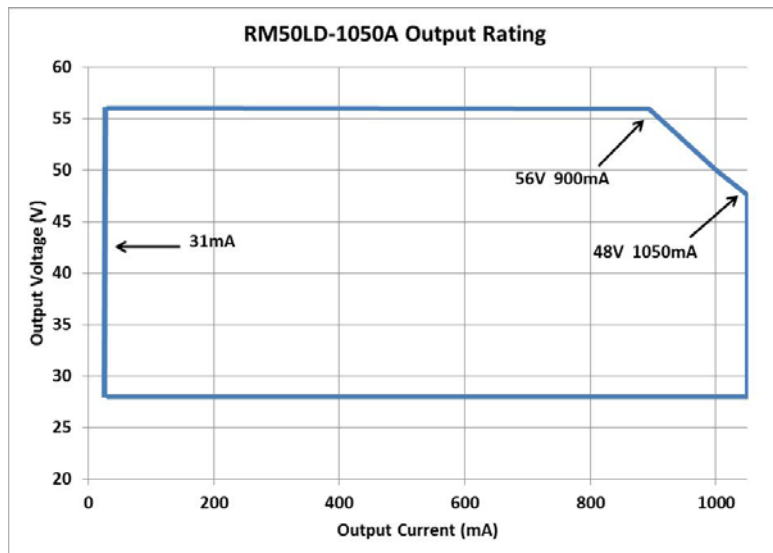
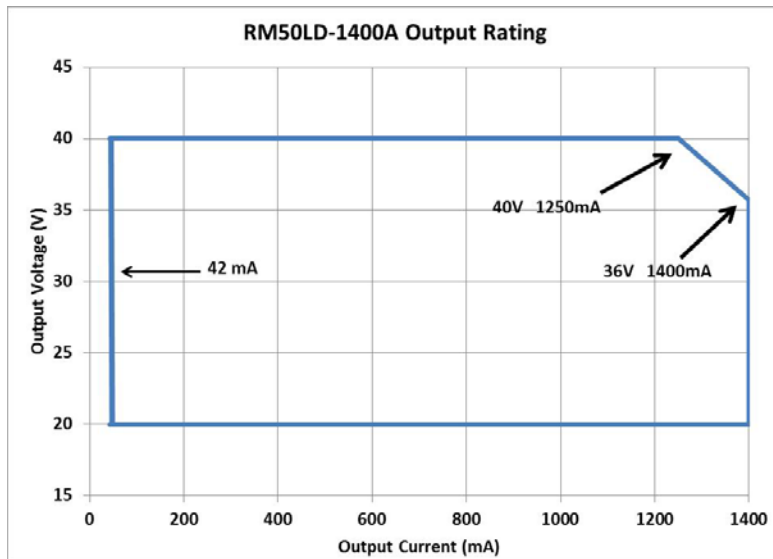

APPLICATIONS AND CONNECTIONS

The MESO 50W LED driver is designed for powering LED luminaries with standard lighting controls.

The modules operate with:

- Standard Light Switches
- Analog Dimmers (0-10V or 1-10V control)
- Push/Step Dim
- DALI/PWM controls (High Voltage also) **(DALI dimming models only)**

The following diagram depicts a typical installation utilizing the MESO 50W LED driver:

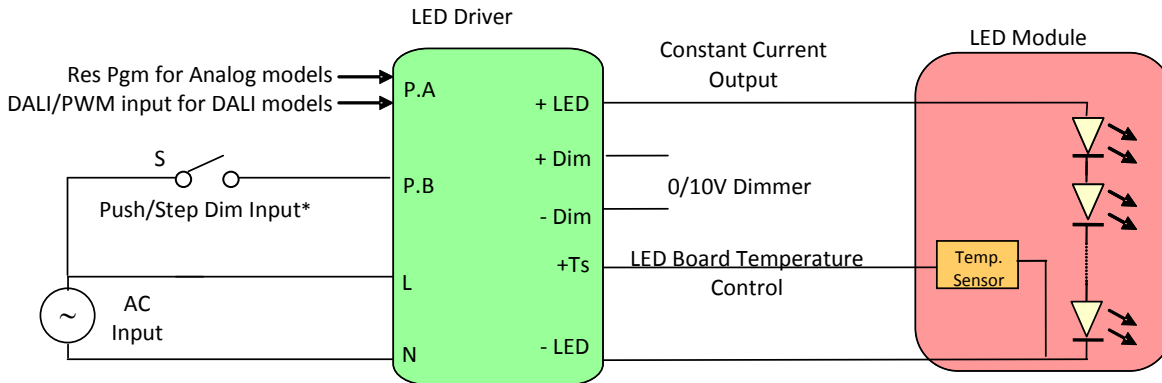

* Push/Step Dim is not available in DC models

P.A= Res Pgm for Analog models
P.A= DALI/PWM input for DALI models

P.B= Push/Step Dim Input*
NEUTRAL
LINE

****Push/Step Dim is not available in DC models***

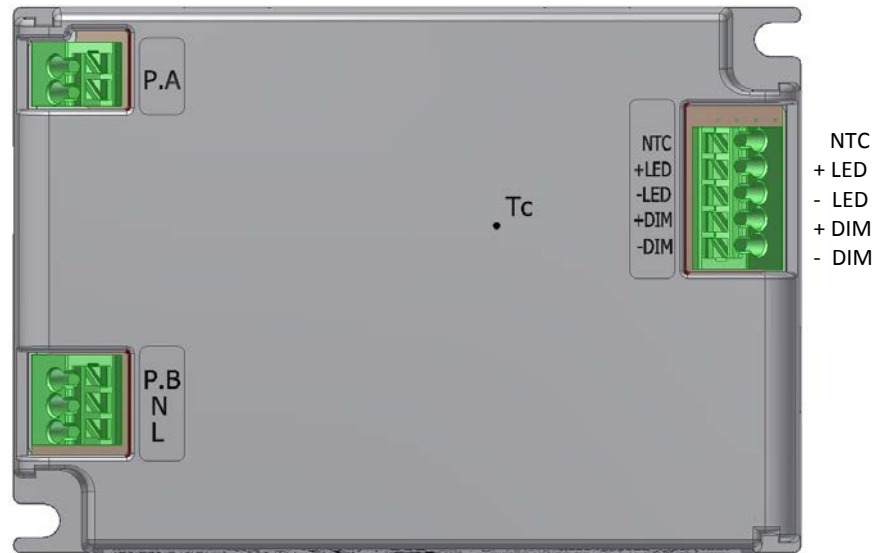

PROGRAMMABILITY

MESO 50W provides 2 methods to program the output characteristics; wireless and wired. Similar features can be programmed through each method. Refer to Output Programmability table on page 6.

Wireless: RFID technology is used to enable true wireless programming of the features without the need to energize or connect the driver to test equipment. A compatible RFID reader and EFORE software is required. Two pad reader options are available. A single driver pad reader is handheld and suitable to program individual drivers. The multiple driver pad reader will program a box of Meso 50 drivers simultaneously, without opening the box.



Single driver pad reader
Order Code: ROALSET-Single



Multiple driver pad reader
Order Code: ROALSET-Multi

Wired: All models can also be programmed with the Ozone Programming Tool (RSOZ070-PTOOL) for backward compatibility. Digital dimming models can be programmed using the DALI Tool (RSOZ070-PDALI).



DALI Programming Tool
Order Code: RSOZ070-PDALI



Ozone Programming Tool
Order Code: RSOZ070-PTOOL

OUTPUT PROGRAMMABILITY

The following table describes the output programmability features of the Meso 50 drivers.

Feature	Selection	Description	Model Availability		Refer to document for details
			Analog	DALI	
Analog Dimming Mode	1-10	Dims to 3% of Iout Max	✓	✓	AN1_Meso50 Wiring Diagram
	0-10	Dims to 3% of Iout Max. When Vdim is <0.85V, output turns off	✓	✓	AN2_Meso 50 Temp Sense & Dimming
Digital Dimming Mode	DALI	Selects either DALI commands or PWM dimming input	✗	✓	AN1_Meso50 Wiring Diagram
	PWM				AN4_Meso50 DALI & PWM Dimming UM1_Ozone_Toolset_Software_Manual
Fade Time	0 sec	Fade in and out timing during dimming			
	2 sec		✓	✓	AN3_Meso50 Setting
	5 sec				
	10 sec				
Step/Push Dimming**	Step	When the P.B. input is open, the output of the driver shall be at the set-point. If the input (P.B.) is closed to the AC line input, the output of the driver shall reduce to 50% of the set-point. This step dim level is programmable from 10% to 90% via Ozone Toolset software only.	✓	✓	AN1_Meso50 Wiring Diagram AN2_Meso50 Temp Sense & Dimming AN3_Meso50 Setting UM1_Ozone_Toolset_Software_Manual
	Push	When the P.B. input is toggled the unit will switch ON/OFF. If the input is held on for more than 5 seconds, the output dims smoothly from the present set-point to 10% and back up to 100%. When the input is opened, the output dimming level will be maintained.	✓	✓	AN1_Meso50 Wiring Diagram AN2_Meso50 Temp Sense & Dimming AN3_Meso50 Setting UM1_Ozone_Toolset_Software_Manual
Output Setpoint	Iset I _{max}	Output setpoint adjustable between Iset and I _{max} in 10mA increments	✓	✓	AN3_Meso50 Setting UM1_Ozone_Toolset_Software_Manual
Adjustable Dimming *	Enabled	When enabled, the driver can be programmed to execute a custom dimming profile consisting of five periods.	✓	✓	UM1_Ozone_Toolset_Software_Manual
	Disabled	Requires the use of an external AC photocell.			
Constant Light Function *	Enabled	When enabled, the output current can be increased along the product life with programmable custom profile to compensate LEDs performance depreciation.	✓	✓	UM1_Ozone_Toolset_Software_Manual
	Disabled				
DC Status *	Enabled	Available on DC input models only.	✓	✓	UM1_Ozone_Toolset_Software_Manual
	Disabled	When enabled, if a DC input is detected, the output current can be set as a percentage of the programmed current (Iset). All dimming features will be disabled.			

Selection values in **bold** are factory defaults

- * Features programmable via the Ozone Toolset only
- ** Step/Push Dimming not available on DC input models

SIGNAL CONNECTIONS

The following table describes the signal connections of the Meso 50 driver, the availability for each model type and the appropriate document to refer to for technical details.

Connection	Function	Description	Model Availability		Refer to document for details																																											
			Analog	DALI																																												
+DIM -DIM	Analog Dimming	Two terminals are provided for analog dimming, referenced to the output of the driver. The analog dimming inputs can be used to adjust the output setting via a standard commercial wall dimmer, an external control voltage source (1 to 10VDC), or a variable resistor. Dimming down to 3% of the max current is possible when set to 1-10 dimming. When set for 0-10 dimming, the output turns off when the dimming input is <0.85V.	✓	✓	AN1_Meso 50 Wiring Diagram AN2_Meso50 Temp Sense & Dimming																																											
NTC	Ext LED Temp Prot	A single terminal is provided for a connection to a 100k NTC thermistor, referenced to the –LED terminal of the driver. The thermistor should be located on the LED assembly to monitor its temperature. If the temperature exceeds a predetermined set point, the output current of the module is automatically reduced to regulate the temperature of the LED at a safe level.	✓	✓	AN1_Meso 50 Wiring Diagram AN2_Meso50 Temp Sense & Dimming																																											
P.A	Res Pgm	<p>Two terminals are provided to set the output current with a resistor. If no resistor is connected, the set-point is determined by the value programmed into the driver. Eight (8) presets are included for each model.</p> <table border="1"> <thead> <tr> <th rowspan="2">Res Pgm Value (kΩ)</th> <th>RM50LD-700A</th> <th>RM50LD-1050A</th> <th>RM50LD-1400A</th> </tr> <tr> <th>Iset (mA)</th> <th>Iset (mA)</th> <th>Iset (mA)</th> </tr> </thead> <tbody> <tr> <td>No Resistor</td> <td>As programmed</td> <td>As programmed</td> <td>As programmed</td> </tr> <tr> <td>90</td> <td>350</td> <td>500</td> <td>700</td> </tr> <tr> <td>40</td> <td>400</td> <td>550</td> <td>800</td> </tr> <tr> <td>24</td> <td>450</td> <td>600</td> <td>900</td> </tr> <tr> <td>15</td> <td>500</td> <td>700</td> <td>1000</td> </tr> <tr> <td>10</td> <td>550</td> <td>800</td> <td>1050</td> </tr> <tr> <td>6.5</td> <td>600</td> <td>900</td> <td>1250</td> </tr> <tr> <td>2.5</td> <td>650</td> <td>1000</td> <td>1300</td> </tr> <tr> <td>0</td> <td>700</td> <td>1050</td> <td>1400</td> </tr> </tbody> </table>	Res Pgm Value (kΩ)	RM50LD-700A	RM50LD-1050A	RM50LD-1400A	Iset (mA)	Iset (mA)	Iset (mA)	No Resistor	As programmed	As programmed	As programmed	90	350	500	700	40	400	550	800	24	450	600	900	15	500	700	1000	10	550	800	1050	6.5	600	900	1250	2.5	650	1000	1300	0	700	1050	1400	✓	✗	AN1_Meso50 Wiring Diagram
	Res Pgm Value (kΩ)	RM50LD-700A		RM50LD-1050A	RM50LD-1400A																																											
Iset (mA)		Iset (mA)	Iset (mA)																																													
No Resistor	As programmed	As programmed	As programmed																																													
90	350	500	700																																													
40	400	550	800																																													
24	450	600	900																																													
15	500	700	1000																																													
10	550	800	1050																																													
6.5	600	900	1250																																													
2.5	650	1000	1300																																													
0	700	1050	1400																																													
	DALI/PWM	<p>Two terminals are provided for dimming inputs, selectable between DALI or PWM via programming methods. Isolated from the driver electronics and may be connected to AC input or DC output referenced circuitry. Output current is controlled via reduction in current.</p> <p>DALI: Dimming to 3% of max current. DALI interface is compatible with IEC62386.</p> <p>PWM: Dims the output of the driver with a pulse width modulated input. Permits a 3% to 100% dimming of the output current and is compliant to EN60929.</p>	✗	✓	AN4_Meso50 DALI and PWM Dimming																																											
P.B	Push / Step Dimming	<p>Single terminal provided for Push or Step Dimming input. Function is selectable via programming methods. Connection to this input shall be to the Line (L) AC input connection.</p> <p>Push Dim: When the input is toggled, the unit will switch ON/OFF. If the input is held on for more than 5 seconds, the output set-point dims smoothly from the present set-point to 10% and back up to 100%. When the input is opened, the output dimming level will be maintained.</p> <p>Step Dim: When the input is open, the output of the driver shall be at the set-point. If the input is connected to the AC line input, the output of the driver shall reduce to 50% of the set-point. This step dim level is programmable from 10% to 90%.</p>	✓	✓	AN2_Meso50 Temp Sense & Dimming																																											

MECHANICAL DETAILS

Enclosure Material: Plastic, meets UL 8750 requirements for Electrical and Fire Enclosure, **UL94 5VA**

I/O Connections: Push in connectors, DALI on primary side.

Ingress Protection: IP20, UL damp rated

Dimensions: 105 x 73 x 27 mm
4.13 x 2.87 x 1.06 in

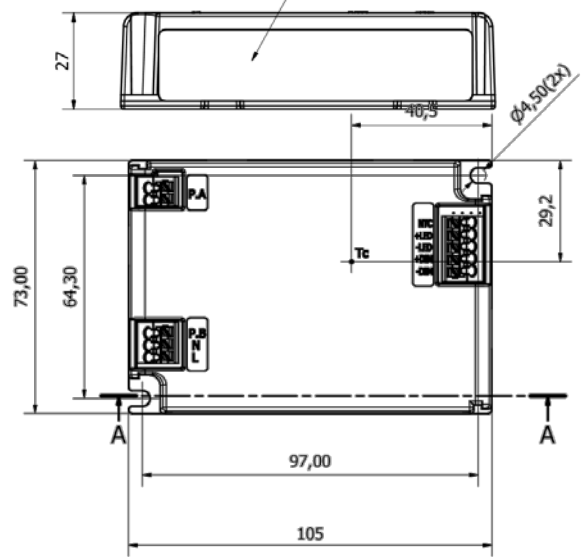
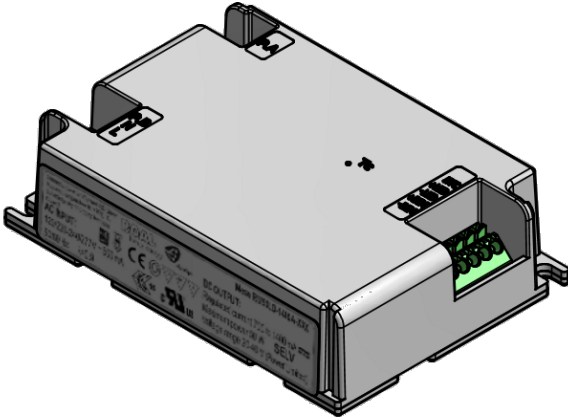

REMOTE GEAR KIT

CODE: RM50LD-RGKIT



With the purchase of the Remote Gear Kit, Meso 50 will meet the requirements of an Independent Unit as per EN61347-2-13

Dimensions: 125 x 73 x 29 mm
4.92 x 2.87 x 1.12 in

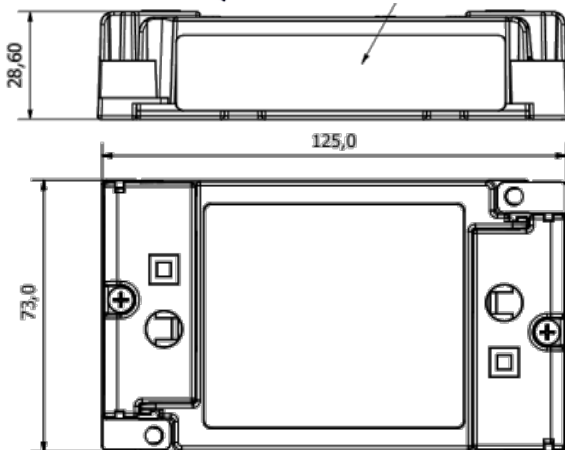
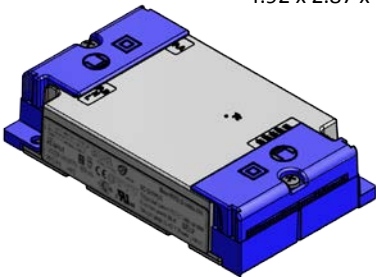

BALLAST MOUNTING KIT

CODE: RM50LD-BMKIT

With the purchase of the Ballast Mounting Kit, Meso 50 can be mounted to standard junction boxes.

Mounting Details: Units come standard with double hole flange mounting, will include 8-32 studs and bottom entry holes.

Dimensions: 140 x 74 x 30 mm
5.51 x 2.91 x 1.18 in

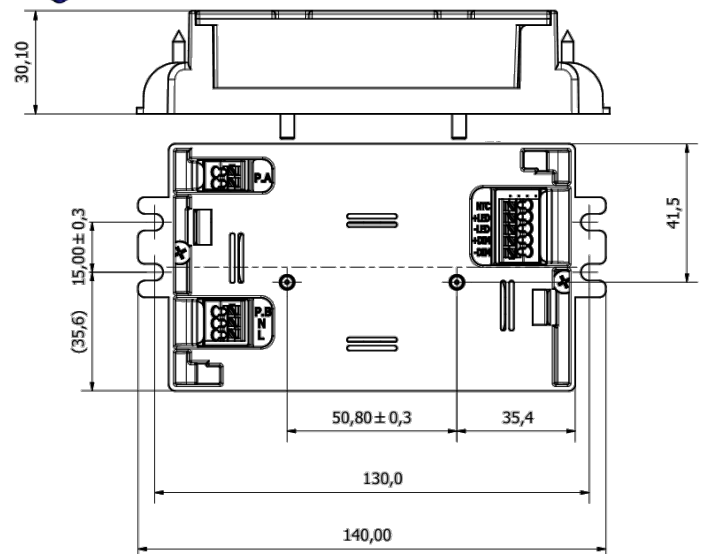
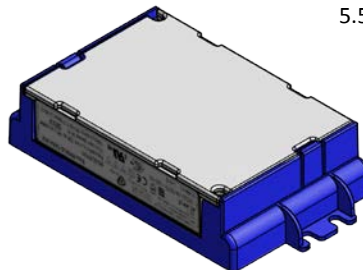

Refer to Application Note AN1_Meso50 Wiring Diagram for assembly details for the optional kits

ENVIRONMENTAL SPECIFICATIONS

Specification	Test Conditions / Notes	Min	Nominal	Max	Units
Top Case Temperature Range	Refer to the Top Case measurement point	-30	-	90	°C
Ambient Temperature Range		-30	-	55	°C
Ambient Temperature Range with Derating	See derating curves for further details	-30	-	70	°C
Cold Start up Ambient		-40	-		°C
Storage Temperature		-40	-	85	°C
Operating Relative Humidity	Non-condensing	5	-	95	%
Surface Temperature	Exposed surfaces temperature under all operating conditions	-	-	90	°C
Cooling	Convection cooled				
MTBF	Full Load, 40°C Ambient, 80% Duty cycle, Telcordia SR-332 Issue 2	-	500.000	-	Hours
Useful Life	Nominal V_{AC} , 80% load, 40°C Ambient.	-	50.000	-	Hours

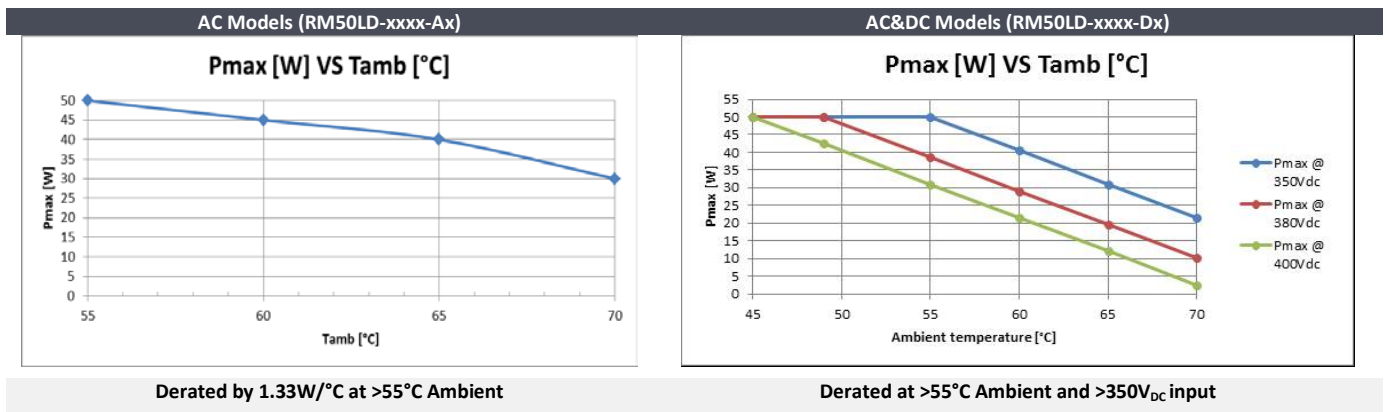
DERATING CURVES







ELECTROMAGNETIC COMPATIBILITY (EMC) – EMISSIONS

Phenomenon	Conditions / Notes	Standard	Equipment Performance Class
Conducted Emission	Test at 230 V_{AC}	EN55015	
Conducted Emission	Test at 120/277 V_{AC}	EN55022	Class B
Radiated Emission	Test at 230 V_{AC}	EN55015	
Conducted and Radiated Emission	Test at 120/277 V_{AC}	FCC CFR47- part 15/subpart B	Class B
Harmonic Current Emissions		EN61000-3-2	Class C
Voltage Changes, Fluctuation and Flicker		EN61000-3-3	

ELECTROMAGNETIC COMPATIBILITY (EMC) – IMMUNITY

Phenomenon	Conditions / Notes	Standard	Note
Equipment for general lighting purposes -EMC Immunity Req.		EN 61547	
ESD (Electrostatic Discharge)		EN 61000-4-2	
Radiated Radio-Frequency electromagnetic field		EN 61000-4-3	
Electric Fast Transient / Burst		EN 61000-4-4	
Surge	Level ± 5.0 kV L-N	EN 61000-4-5	
Conducted disturbances induced by Radio-Frequency fields		EN 61000-4-6	
Voltage Dips, short interruptions and Voltage Variations		EN 61000-4-11	
Non repetitive damped oscillatory transient, Ring wave		ANSI C.62.41	Category A

SAFETY AGENCIES APPROVALS

Certification Body	Safety Standards	Category
	UL Recognized ANSI / UL8750, 1 st Ed., CSA C22.2 No.250-13, 7 th Ed. Models with output voltages <60 V _{DC} include UL and CSA approval (cURus) as Class 2 output. LED Driver suitable for dry and damp location	
	UL approval as a fire and mechanical enclosure, UL94 5VA	
	IEC/EN 61347-2-13 electronic control gear for LED Modules IEC/EN 62384 DC or AC supplied electronic control gear for LED modules – Performance Requirements	
	To obtain the “CE Declaration of Conformity” please contact info@efore.com	
	Independent unit as per EN61347-2-13 with an optional remote gear kit RM50LD-RGKIT	

Specifications appearing in EFORE’s catalogues and brochures as well as any oral statements are not binding. All descriptions, drawings and other particulars (including dimensions, materials and performance data) given by EFORE are as accurate as possible but, being given for general information, and are not binding on EFORE. EFORE makes thus no representation or warranty as to the accuracy of such material. We assume no liability other than as agreed in the terms of the individual contracts and we reserve the right to make technical modifications in the course of our product development. Our product information solely describes our goods and services and is in no way to be construed or interpreted as a quality or condition guarantee. The aforesaid shall not relieve the customer of its obligation to verify the suitability of our Products for the use or application intended by the purchaser. Customers are responsible for their products and applications. EFORE assumes no liability from the use of its products outside of specifications. No license is granted to any intellectual property rights by this document.